

# *Xterio*

| Cornice, Brackets & Dentils



# Cornices



**C800**

2000 x 65 x 57 mm  
Purotouch®



**2**

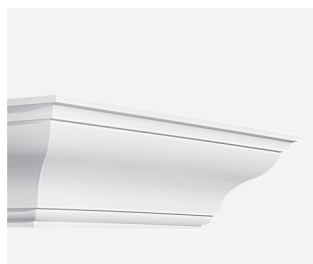

**C833**

2000 x 122 x 111 mm  
Purotouch®

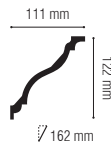

**2**



**C890**

2000 x 159 x 216 mm  
Purotouch®

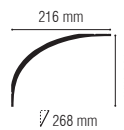

**C843 HERITAGE XL**

2000 x 190 x 250 mm  
Purotouch®

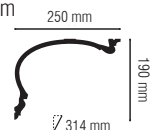

NEW



**C835**

200 x 202 x 222 mm  
Purotouch®

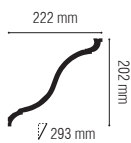

**C832**

2000 x 230 x 114 mm  
Purotouch®

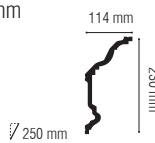

**1**

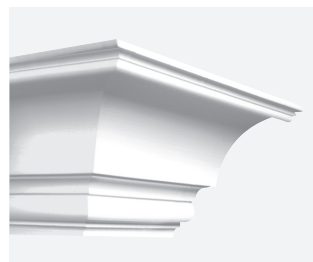

**C836**

2000 x 271 x 266 mm  
Purotouch®

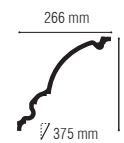

**front**



**C844 HERITAGE XXL**

2000 x 273 x 350 mm  
Purotouch®

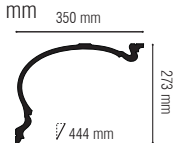

NEW

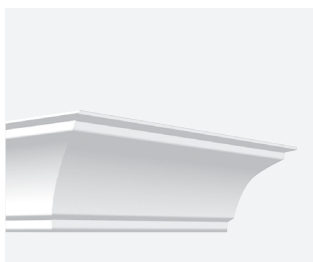

**C820**

2000 x 160 x 200 mm  
Purotouch®

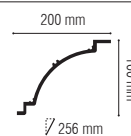

**3**

## Finishing elements to suit C820

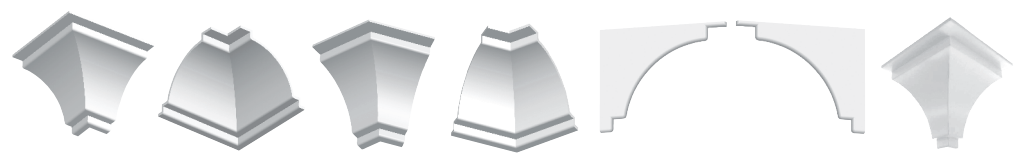

**C820A** **3a**

**C820B** **3b**

**C820C**

**C820D**

**C820E**

**C820F**

**C820G** **3c**

Outer corner 90° Inner corner 90° Outer corner 135° Inner corner 135° Stop end left Stop end right Mitre stop end

# Brackets

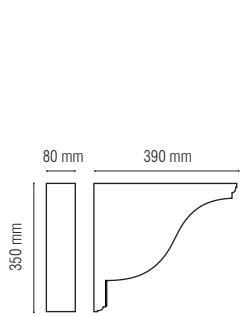

**FC01**

80 x 350 x 390 mm  
Purotouch®

4

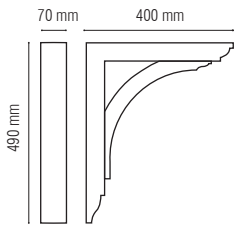

**GB02 \***

70 x 490 x 400 mm  
Purotouch®  
Structural max. 35 kg

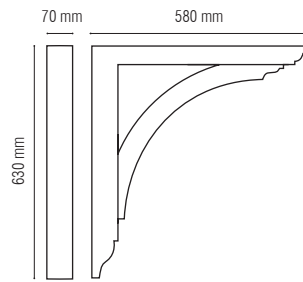

**GB03 \***

70 x 630 x 580 mm  
Purotouch®  
Structural max. 75 kg

5

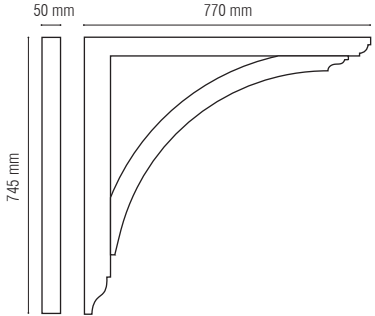

**GB04 \***

50 x 745 x 770 mm  
Purotouch®  
Structural max. 75 kg

6

\*white wood grain finish

# Dentils



**TF01**

77 x 123 x 350 mm  
Purotouch®



**TF02**

77 x 120 x 105 mm  
Purotouch®



**TF03**

77 x 100 x 200 mm  
Purotouch®

7



**TF04**

77 x 200 x 250 mm  
Purotouch®

8

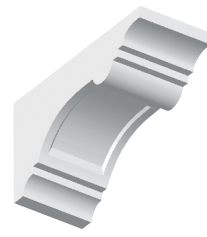

**TF05**

100 x 135 x 255 mm  
Purotouch®

9

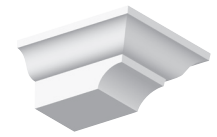

**TF06**

155 x 75 x 175 mm  
Purotouch®

# Rafter Foot

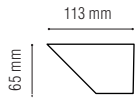

**RF01**

10

48 x 65 x 113 mm  
with unique click system  
Purotouch®

# Installation

| of the Xterio Collection



Ask for a free  
new Orac Decor Book  
and samples on:  
[www.oracdecor.com](http://www.oracdecor.com)



**DecoFix Hydro**  
**FDP700**

**Gluing on wall and ceiling**  
290 ml for 7 to 8 m



**Extra strong MS polymer glue for exterior applications, non-porous (tiles, glass, ...) surfaces and damp environments**

- Remove with soap solution
- Paintable after hardening (min. 24 hrs.)



**DecoFix Extra**  
**FX200**

**Joints**  
310 ml for min. 80 m



+

**Polyurethane-based glue to seam joints between mouldings**

- Remove excess glue before hardening (max. 1 hour and repeat after 2-3 hrs.)
- Clean with acetone or synthetic thinner
- Can be painted after 24 hrs.
- The more humidity, the faster the drying time

**ONLY FULL GUARANTEE WITH DECOFIX**

# Benefits

| of the Xterio Collection



**UV STABLE**  
**NO DISCOLORATION**



**BRITAIN'S TOP**  
**DENTIL SUPPLIER**



**NO NEED TO BUY**  
**IN PACK QUANTITIES**

**ITEMS IN STOCK FOR**  
**IMMEDIATE DISPATCH**

# Discover also

| Our Interior Solutions



# Contact

| Dealer Information

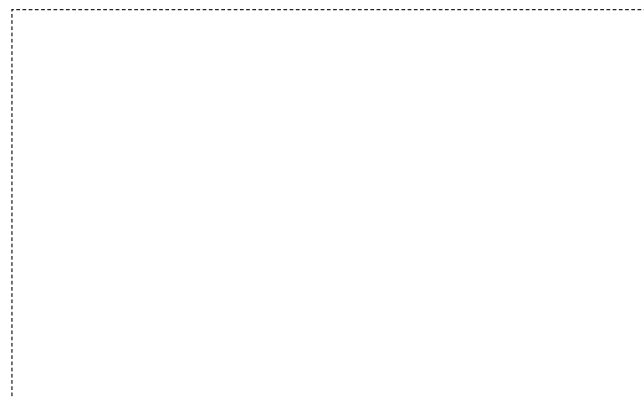

More information on [www.oracdecor.com](http://www.oracdecor.com)